

**ZEUS-247/227/197**

24"/22"/19" LCD with LED Backlight

Intel® Core™ i7 Quad Core/Dual Core Processor

Intel® QM77 Chipset

Smart View Medical Station

ZEUS-247/ZEUS-227/ZEUS-197 Manual 1st Ed  
Jan, 2013

## Copyright Notice

This document is copyrighted, 2012. All rights are reserved. The original manufacturer reserves the right to make improvements to the products described in this manual at any time without notice.

No part of this manual may be reproduced, copied, translated, or transmitted in any form or by any means without the prior written permission of the original manufacturer. Information provided in this manual is intended to be accurate and reliable. However, the original manufacturer assumes no responsibility for its use, nor for any infringements upon the rights of third parties, which may result from its use.

The material in this document is for product information only and is subject to change without notice. While reasonable efforts have been made in the preparation of this document to assure its accuracy, ONYX Healthcare Inc., assumes no liabilities resulting from errors or omissions in this document, or from the use of the information contained herein

ONYX Healthcare Inc. reserves the right to make changes in the product design without notice to its users

## Acknowledgments

---

- Intel® Core™ i7 is registered trademarks of Intel® Corporation.
- IBM, PC/AT, PS/2 are trademarks of International Business Machines Corporation.
- Microsoft® Windows is a registered trademark of Microsoft® Corporation.
- RTL is a trademark of Realtek Semi-Conductor Co., Ltd.
- C&T is a trademark of Chips and Technologies, Inc.
- UMC is a trademark of United Microelectronics Corporation.
- ITE is a trademark of Integrated Technology Express, Inc.
- SiS is a trademark of Silicon Integrated Systems Corp.
- VIA is a trademark of VIA Technology, Inc.

All other product names or trademarks are properties of their respective owners.



## Packing List

---

Before you begin installing your Medical Station, please make sure that the following items have been shipped:

- ZEUS-247/227/197 Smart View Medical Station
- Utility CD-ROM, which contains Drivers and Utilities

If any of these items are missing or damaged, you should contact your distributor or sales representative immediately.

### Headquarters

Onyx Healthcare Inc.

2F, No.135, Lane 235, Pao-Chiao Rd.,

Hsin-Tien City, Taipei 231, Taiwan, R.O.C.

TEL: +886-2-8919-2188

FAX: +886-2-8919-1699

E-mail: [sales@onyx-healthcare.com](mailto:sales@onyx-healthcare.com)

<http://www.onyx-healthcare.com>

### Worldwide Offices:

Onyx Healthcare, USA Inc.

2663 Saturn street, Brea, CA 92821, USA

Tel : +1-714-996-1800  
Fax: +1-714-996-1811  
Email: usasales@onyx-healthcare.com

Onyx Healthcare EUROPE B.V.  
Ekkersrijt 4002, 5692 DA Son, The Netherlands  
Tel : +31-(0)499-462020  
Fax: +31-(0)499-462010  
Email: eusales@onyx-healthcare.com

Onyx Healthcare Technology GmbH  
An der Trift65d  
63303 Dreieich , Germany  
TEL: +49-(0)61033-7479-00  
Fax: +49-(0)61033-7479-49  
Email: eusales@onyx-healthcare.com

Onyx Healthcare (SU ZHOU) INC.  
Room 12, 2F, Building B, No.5 Xing Han Street, Suzhou Industrial  
Park, Jiang Su Province, China

**Smart View  
Medical Station**

**ZEUS-247/227/197**

Tel: +86-512-67625700

Fax: +86-512-67617337

Email: [cnsales@onyx-healthcare.com](mailto:cnsales@onyx-healthcare.com)

Onyx Healthcare Singapore PTE LTD

57 Genting Lane, #07-00, Singapore 349564

Tel: +65-67498749

Fax +65-67461595

Email: [sgsales@onyx-healthcare.com](mailto:sgsales@onyx-healthcare.com)



## Safety & Warranty

---

1. Read these safety instructions carefully.
2. Keep this user's manual for later reference.
3. Disconnect this equipment from any AC outlet before cleaning. Do not use liquid or spray detergents for cleaning. Use a damp cloth.
4. For pluggable equipment, the power outlet must be installed near the equipment and must be easily accessible.
5. Keep this equipment away from humidity.
6. Put this equipment on a reliable surface during installation. Dropping it or letting it fall could cause damage.
7. The openings on the enclosure are for air convection. Protect the equipment from overheating. **DO NOT COVER THE OPENINGS.**
- 8. Make sure the voltage of the power source is correct before connecting the equipment to the power outlet.**
9. Position the power cord so that people cannot step on it. Do not place anything over the power cord.
10. All cautions and warnings on the equipment should be noted.
11. If the equipment is not used for a long time, disconnect it from the power source to avoid damage by transient over-voltage.
12. Never pour any liquid into an opening. This could cause fire or electrical shock.
13. Never open the equipment. For safety reasons, only qualified

service personnel should open the equipment.





**14. If any of the following situations arises, get the equipment checked by service personnel:**

- a. The power cord or plug is damaged.
- b. Liquid has penetrated into the equipment.
- c. The equipment has been exposed to moisture.
- d. The equipment does not work well, or you cannot get it to work according to the users manual.
- e. The equipment has been dropped and damaged.
- f. The equipment has obvious signs of breakage.

**15. DO NOT LEAVE THIS EQUIPMENT IN AN UNCONTROLLED ENVIRONMENT WHERE THE STORAGE TEMPERATURE IS BELOW -20° C (-4°F) OR ABOVE 60° C (140° F). IT MAY DAMAGE THE EQUIPMENT.**

**16. External equipment intended for connection to signal input/output or other connectors, shall comply with relevant UL / IEC standard (e.g. UL 1950 for IT equipment and ANSI/AAMI ES 60601-1: 2005 AND CAN/CSA-C22.2 No. 60601-1:08 / IEC 60601 series for systems – shall comply with the standard IEC 60601-1-1, Safety requirements for medical electrical systems. Equipment not complying with UL 60601-1 shall be kept outside the patient environment, as defined in the standard.**

*Caution:*

*It may cause the danger of explosion if battery is incorrectly replaced. Replace only with same or equivalent type recommended by the manufacturer.*



## Classification

---

1. Degree of protection against electric shock: not classified
2. Degree of protection against the ingress of water: IPX0
3. Mode of operation: Continuous
4. Type of protection against electric shock: Class I equipment
5. No Applied Part, No AP/APG



## FCC

---

*Warning!*



This device complies with Part 18 FCC Rules. Operation is subject to the following two conditions: (1) this device may not cause harmful interference, and (2) this device must accept any interference received including interference that may cause undesired operation.





## UL Module Description

---

 The logo consists of a circle with the word "CLASSIFIED" at the top, "C" on the left, "UL" in the center, and "US" on the right.	<p><i>ZEUS-247/227/197 modules are developed to suitable for the Classification Mark requirement</i></p>
--	--

## Safety Symbol Description

The following safety symbols are the further explanations for your reference.

	<p>Medical equipment with respect to electric shock, fire and mechanical hazards only in accordance with <b>ANSI/AAMI ES 60601-1:2005 AND CAN/CSA-C22.2 No. 60601-1:08</b></p>
	<p>Attention, consult ACCOMPANYING DOCUMENTS.</p>
	<p>Stand-by (<b>Green light</b>)</p>
	<p>Ground wire Protective Ground wire.</p>
	<p>Medical equipment with respect to electric shock, fire and mechanical hazards only in accordance with UL 60601-1, and CAN/CSA C22.2 NO. 601.1</p>

## Contents

### Chapter 1 General Information

1.1 Introduction .....	1-2
1.2 Feature .....	1-3
1.3 Specification.....	1-4
1.4 Dimension.....	1-8

### Chapter 2 Hardware Installation

2.1 Safety Precautions.....	2-2
2.2 Quick Tour of the ZEUS-247/227/197 .....	2-3
2.3 Turn On and Boot up into Windows.....	2-7
2.4 Turn off.....	2-7

### Chapter 3 Driver Installation

### Appendix A Miscellanea

A.1 General Cleaning Tips.....	C-2
A.2 Cleaning Tools.....	C-3
A.3 Scrap Computer Recycling .....	C-5



Chapter

1

# General Information

## 1.1 Introduction

---

The ZEUS-247/227/197 Smart View Medical Stations are based on Intel® Core™ i7 Quad Core/Dual Core processor, which delivers a performance improvement of more than 100 percent compared to systems running traditional single-core processors. With two/four cores, or computing engines, ONYX can simultaneously execute two/four computing tasks. It accommodates one 2.5" SATA hard disk drive/SSD and two DDRIII SODIMM up to 16GB.

The high brightness LCD, Low Noise solution, integrated multimedia functions and extensive expansion options make them the perfect platform upon which to build comprehensive lifestyle computing applications.

The ZEUS-247/227/197 include all the features of a powerful computer into a slim and attractive chassis. The ZEUS-247 has a 24" 300 nits TFT display with 1920 x 1200 resolutions. ZEUS-227 has a 22" 300 nits TFT display with 1920 x 1080 resolutions. ZEUS-197 has a 19" 300 nits TFT display with 1280 x 1024 resolutions. Integrating with high brightness LCD is easier to analyze DICOM image. ZEUS series owns side mount USB 3.0 ports, slim DVD-RW drive and a smart card reader to support high speed data transfer and ID check by smart card reader. Combining the ZEUS-247/227/197 into your system can achieve both cost-saving and efficient improvements in common applications including Surgical, Radiology, PACS (Picture Archiving



Communication Systems), LIS (Lab Information Systems) and Electronic Medical Record. The ZEUS-247/227/197 are definitely your perfect choices.

## 1.2 Feature

---

- 24"/22"/19" Intel® Core™ i7 Quad Core/Dual Core Processor
- Supports Dual Channel DDR3 SODIMM up to 16GB
- Built-in RFID and Smart Card Security (Optional)
- Supports PCI Express[x16] Expansion
- High Speed USB 3.0 Ports
- 10 Smart Function Keys
- DICOM Compliance(optional)

### 1.3 Specification

#### Hardware Specifications

<b>Display</b>	ZEUS-247: 24" 1920x1200 LCD ZEUS-227: 22" 1920x1080 LCD ZEUS-197 19" 1280x1024 LCD
<b>CPU</b>	Intel® Core™ i7/i3 Processor
<b>Disk Drive Space</b>	2.5" Hard Disk Drive/Solid State Drive Slim DVD-RW Drive (optional)
<b>Expansion</b>	One PCI Express[x16] expansion
<b>Function Key</b>	Power On/Off, Speaker Volume Up/Down, LCD Brightness Up/Down, LCD On/Off, Touch Screen On/Off, Display Mode(optional), Reading Light On/Off
<b>I/O</b>	1x Isolated RS-232 port 1x Isolated USB 2.0 port 4x USB 2.0 ports 4x USB 3.0 ports 2x Isolated Gigabit LAN 1x Display Port <i>Sound:</i> 1 x Line-out 1 x Mic-in

#### LCD Specifications

Model Name	ONYX-247 series	ONYX-227 series
<b>Display Type</b>	24" LCD	22" LCD
<b>Max. Resolution</b>	1920 x 1200	1920 x 1080
<b>Max. Colors</b>	16.7M	16.7M

<b>Dot Size (mm)</b>	0.297 x 0.297	0.294 x 0.294
<b>Luminance (cd/m2)</b>	300(TYP)	300 or 250 (TYP)
<b>Back Light Life Time</b>	30,000 Hrs	50,000 or 30,000 Hrs

<b>Model Name</b>	ONYX-197 series
<b>Display Type</b>	19" LCD
<b>Max. Resolution</b>	1280 x 1024
<b>Max. Colors</b>	16.7M
<b>Dot Size (mm)</b>	0.297 x 0.297
<b>Luminance (cd/m2)</b>	300 or 350(TYP)
<b>Back Light Life Time</b>	50,000 Hrs

**Note:**

All ONYX LCD products are manufactured with High precision technology. However, there are a small number of defective pixels in all LCD panels that are not able to change color. This is a normal occurrence for all LCD displays from all manufacturers and should not be noticeable or objectionable under normal operation. All LCD panels are qualified for industry standard conditions in the following: total 7 dead pixels on a screen or if there are 3 within 1 inch square area of each other on the display.

### Mechanical Specifications

<b>Architecture</b>	Close-frame
<b>Front Bezel</b>	Plastic bezel with resistive touch screen
<b>Color</b>	White
<b>Mounting / Holder</b>	VESA 75/100mm
<b>Construction</b>	3mm ABS + PC TYPE Plastic housing
<b>Dimension (WxHxD)</b>	ZEUS-247: 600mmx 415mm x 65 mm ZEUS-227: 546mm x 351mm x 66mm ZEUS-197: 450mm x 388mm x 66mm
<b>Net Weight</b>	ZEUS-247: 21.4 lb (9.7 Kg) ZEUS-227: 18.7 lb (8.5 kg) ZEUS-197: 16.5lb (7.5Kg)

### Power Supply Specifications

<b>Model</b>	POWER-WIN PW-M110A-1Y240G
<b>Input Voltage</b>	90~264 V AC, 2A max. @ 47 ~ 63 Hz
<b>Output Voltage</b>	24V, 4.6A, 110W max.
<b>MTBF</b>	100,000 hrs operation at 25°C

**Environmental Specifications**

<b>Operating Temperature</b>	0°C to 40°C (32°F ~104°F)
<b>Storage Temperature</b>	-20°C to 60°C (-4°F ~140°F)
<b>Storage Humidity</b>	5% to 95% @ 40°C, non-condensing
<b>Vibration</b>	0.5G / 5 ~ 500Hz (Random) / operation
<b>Shock</b>	15G peak acceleration (11 msec. duration) / operation
<b>Drop</b>	76cm (1 Corner, 3 Edge, 6 Surface)
<b>EMI / Safety</b>	CE / FCC Class B/UL 60601-1/EN 60601-1
<b>IP</b>	Front bezel, IP-65 Certified
<b>Noise</b>	35db (full operation)

**Touch Screen (Optional)**

<b>Type</b>	Projective Capacitive / 5-wire Resistive
<b>Interface</b>	USB interface
<b>Light Transmission</b>	> 75%
<b>Life Time</b>	35 million activations

### 1.4 Dimension

ZEUS-247

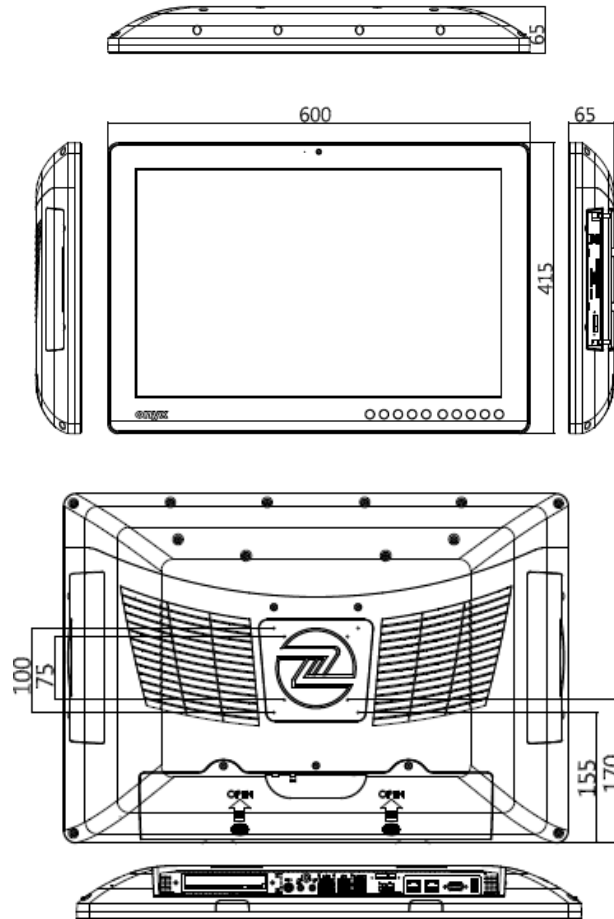

ZEUS-227

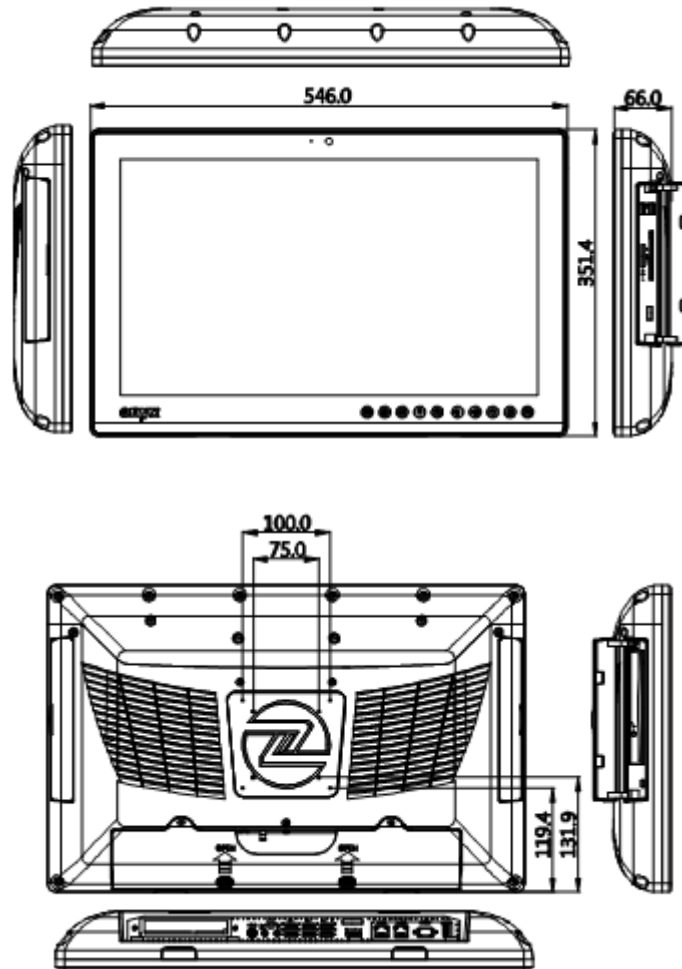



ZEUS-197

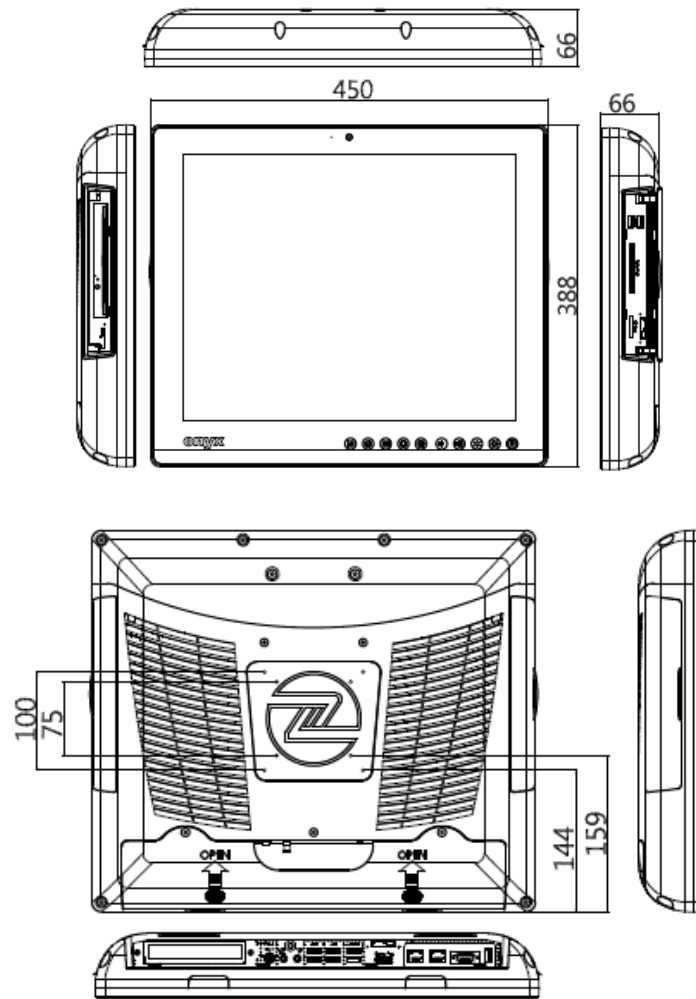

Chapter

2

# Hardware Installation

## 2.1 Safety Precautions

---

**Warning!**



*Always completely disconnect the power cord from your board whenever you are working on it. Do not make connections while the power is on, because a sudden rush of power can damage sensitive electronic components.*

**Caution!**



*Always ground yourself to remove any static charge before touching the board. Modern electronic devices are very sensitive to static electric charges. Use a grounding wrist strap at all times. Place all electronic components on a static-dissipative surface or in a static-shielded bag when they are not in the chassis*

## 2.2 Quick Tour of the ZEUS-247/227/197

Before you start to set up the ZEUS-247/227/197, take a moment to become familiar with the locations and purposes of the controls, drives, connections and ports, which are illustrated in the figures below.

When you place the ZEUS-247/227/197 upright on the desktop, its front panel appears as shown in Picture 2-1.

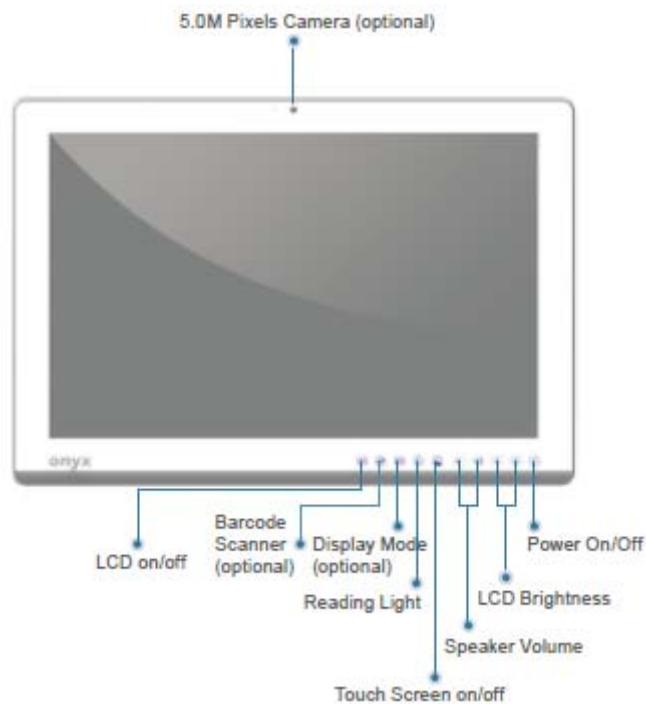

**Picture 2.1: Front View of the Zeus Series**

When you turn the Medical Station around and look at its rear cover, the sunken I/O section is at the bottom of the station, as shown in Picture 2-2. (The I/O section includes various I/O ports, including a serial port, Display Port, the Ethernet ports, USB ports, the microphone jack, PCI Express slot, and so on.) The Medical Station integrates WLAN function by using Mini Card.

ZEUS-247

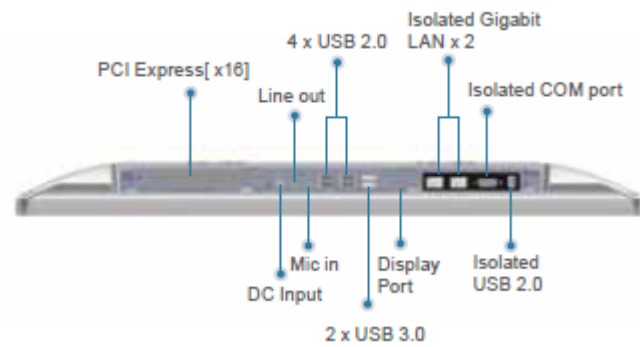

ZEUS-227

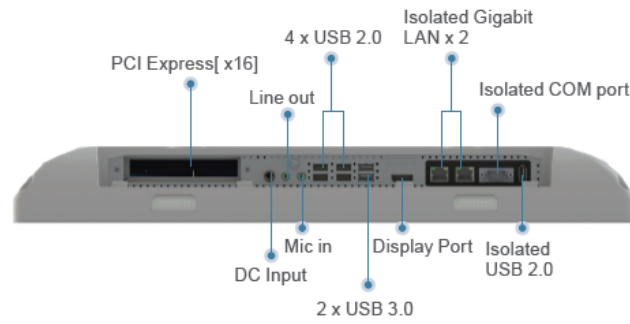

ZEUS-197

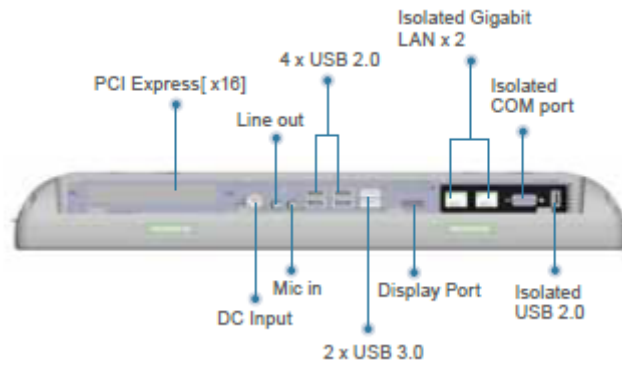

*Picture 2.2: Rear view of the Zeus Series*

When you turn the Medical Station around and look at its left side, two USB 3.0 ports, the smart card reader and DVD-RW drive are on

the right side and the left side of the Medical Station as shown in Picture 2-3.

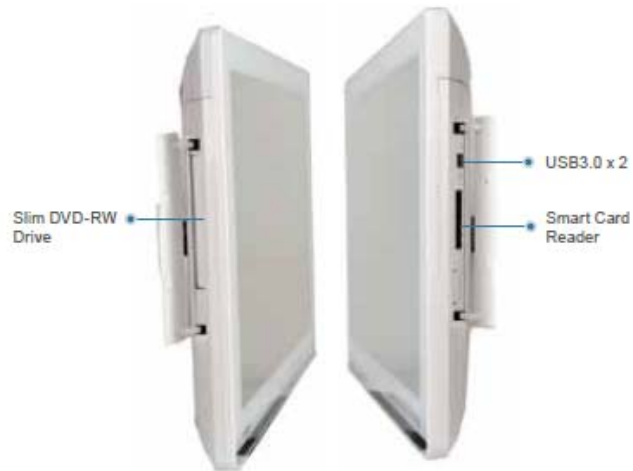

*Picture 2.3: Left view of the Zeus Series*

### 2.3 Turn On and Boot up into Windows OS

---

This section is for Windows operating system only. If you are installing a different operating system, please contact your vendor for installation details.

Your ZEUS will begin loading Windows OS once you push the power button to turn power on. After less than one minute, Windows desktop screen will appear.

You can select the programs from the start menu in the left-down corner of the desktop screen.

### 2.4 Turn off

---

Turning off ZEUS properly is important for system reliability. There are two ways to turn off the system.

1. On the start menu, click "shut down" and select "OK"
2. Push the power button and then the system will shut down automatically



Chapter

3

# Driver Installation

There are several installation ways depending on the driver package under different Operating Systems.

***Please follow the sequence below to install the drivers:***

- Step 1 – Install INF Driver
- Step 2 – Install VGA Driver
- Step 3 – Install LAN Driver
- Step 4 – Install Audio Driver
- Step 5 – USB 3.0 Driver
- Step 6 – RAID&AHCI Driver
- Step 7 – ME Driver
- Step 8 – TPM Driver
- Step 9 – Serial Port Driver(optional)
- Step 10 – Smart Card Driver
- Step 11 – Touch Panel Driver

Appendix

A

**Miscellanea**

## A.1 General Cleaning Tips

---

You may need the following precautions before you begin to clean the computer. When you clean any single part or component for the computer, please read and understand the details below fully.

1. Never spray or squirt the liquids directly onto any computer component. If you need to clean the device, please rub it with a piece of dry cloth.
2. Be cautious of the tiny removable components when you use a vacuum cleaner to absorb the dirt on the floor.
3. Turn the system off before you start to clean up the component or computer.
4. Never drop the components inside the computer or get circuit board damp or wet.
5. Be cautious of all kinds of cleaning solvents or chemicals when you use it for the sake of cleaning. Some individuals may be allergic to the ingredients.
6. Try not to put any food, drink or cigarette around the computer.
7. ONYX Healthcare Inc. has tested and verified these cleaning disinfectants, CIDEX, Viraguard, Control III Disinfectant Germicide, Caviwipes, Dispatch Disinfectant Cleaner CLH69101, Puregreen 24 Disinfectant, can be used with the ONYX-175/195. Use of any other

disinfectants will void the warranty.

## A.2 Cleaning tools

---

Although many companies have created products to help improve the process of cleaning your computer and peripherals users can also use household items to clean their computers and peripherals. Below is a listing of items you may need or want to use while cleaning your computer or computer peripherals.

Keep in mind that some components in your computer may only be able to be cleaned using a product designed for cleaning that component, if this is the case it will be mentioned in the cleaning tips.

- **Cloth** - A piece of cloth is the best tool to use when rubbing up a component. Although paper towels or tissues can be used on most hardware as well, we still recommend you to rub it with a piece of cloth.
- **Water or rubbing alcohol** – You may moisten a piece of cloth a bit with some water or rubbing alcohol and rub it on the computer. Unknown solvents may be harmful to the plastics parts.
- **Vacuum cleaner** - Absorb the dust, dirt, hair, cigarette particles, and other particles out of a computer can be one of the best methods of cleaning a computer. Over time these items can restrict the airflow in a computer and cause

circuitry to corrode.

- **Cotton swabs** - Cotton swabs moistened with rubbing alcohol or water are excellent tools for wiping hard to reach areas in your keyboard, mouse, and other locations.
- **Foam swabs** - Whenever possible it is better to use lint free swabs such as foam swabs.

**Note:**

*We strongly recommended that you should shut down the system before you start to clean any single components.*

**Please follow the steps below.**

1. Close all application programs.
2. Close operating software.
3. Turn off power switch
4. Remove all device
5. Pull out power cable

### A.3 Scrap Computer Recycling

---

If the computer equipments need the maintenance or are beyond repair, we strongly recommended that you should inform us as soon as possible for the suitable solution. For the computers that are no longer useful or work well, please contact with worldwide distributors for recycling.

The worldwide distributors show on the following website:

<http://www.onyx-healthcare.com.tw/Contact.php>

**Note:**

Follow the national requirement to dispose unit